

Threaded inserts for plastic and wood

Ensat®
B-Lok®
Mubux®-A
S-Lok®



Technical publication

No.30



Fastening technology from KerbKonus are in successful applications in a wide variety of different industrial sectors around the world.

State-of-the-art production facilities provide our customers with the assurance of quality and reliable delivery, and sophisticated fastening solutions for every conceivable field of application are implemented by our own Research and Development Department.

Close cooperation and exchange of experience and expertise on an international level ensure that our company stays at the cutting edge of technological development.

With independent branches and agencies operating in a number of countries around the world we are a truly reliable partner when it comes to secure fastening technology.

... our products and services

Depending on the required anchoring method in the material, KerbKonus offers a variety of threaded insert options:

- self-tapping threaded inserts for metal, wood and plastics,
- Threaded inserts for cold embedding
- Threaded inserts for hot or ultrasound embedding
- Threaded inserts for screwing into an internal thread
- Threaded inserts for riveting

Alongside its long-standing, proven spectrum of threaded inserts for a wide variety of applications, KerbKonus also offers a range of fastening technology-related products and services:

- Punched rivet system for thin mouldings
- Screw locking
- Thread sealing systems
- Insulating plastic coating

If you have a specific problem related to the field of fastening technology - with its rich fund of expertise and comprehensive product range, KerbKonus has the solution for you.

Technical details on KerbKonus products are also provided on our homepage: www.kerbkonus.de

Kerb-Konus-Vertriebs-GmbH

Wernher-von-Braun-Straße 7
Industriegebiet Nord

D-92224 Amberg

Phone +49 9621 679-0
Fax +49 9621 679444
e-mail KKV-Amberg@kerbkonus.de

Internet www.kerbkonus.de



Dimensions Product features Receiving hole Pull-out strength Specifications Other details

Threaded inserts from KerbKonus ...

Tested quality; Test methods
 Ensats - the self-tapping threaded insert; Pull-out strength; Installation

Page 2 and 3
 Page 4 to 6

Ensats®-S 302 and Ensats®-SD 303



M2 to M30 or M3 to M10	Self-tapping with cutting slot As above, but in a special thin-walled version	Drilled	Very high Very high	Works standard 302 Thin-wall works standard 303	Page 8 to 9 Page 11
------------------------------	--	---------	----------------------------	--	----------------------------

Ensats®-SB 307/308 and Ensats®-SBD 347/348



M3 to M16 or M3,5 to M16	Self-tapping with cutting slot with three cutting bores As above, but in a special thin-walled version	Drilled	Very high	Works standard 307/308 Thin wall works standard 347/348	Page 10 Page 11
--------------------------------	---	---------	-----------	--	------------------------

Ensats®-SH 309 and Ensats®-SHI 309 2

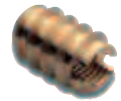

M2,5 to M16	Self-tapping or thread forming or hexagonal socket	Pre-formed or drilled	Very high	Works standard 309	Page 12
-------------	--	-----------------------	-----------	--------------------	---------

Ensats® -3F 305

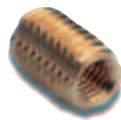

M3 to M16	Thread forming	Pre-formed or drilled	High	Works standard 305	Page 13
-----------	----------------	-----------------------	------	--------------------	---------

Ensats®-SB 302 2 and Ensats®-SBI 307 2/308 2



M4 to M12	Self-tapping with cutting slot or 3 cutting bores and hexagonal socket	Drilled	Very high	Works standard 307 2 Works standard 308 2	Page 14
-----------	--	---------	-----------	--	---------

Mubux®-A



M2 to M10 also as threaded pin	Press-in insert with helically knurled locking profile	Drilled	Medium	Works standard 850 to 857	Page 15 to 17
-----------------------------------	--	---------	--------	---------------------------	---------------

B-Lok®

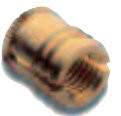

M2 to M8	Expansion insert with screw locking effect	Drilled	Medium	Works standard 812 to 842	Page 18 to 21
----------	--	---------	--------	---------------------------	---------------

S-Lok®



M2 to M10 also as threaded pin	For embedding using ultrasound or heat transmission	Drilled	High	Works standard 860 to 867	Page 22 to 27
-----------------------------------	---	---------	------	---------------------------	---------------

Screw-in tools ...

Tools 620 / 621 / 610 / 6102

Page 6

Ensats installation ...

Machine installation

Page 7

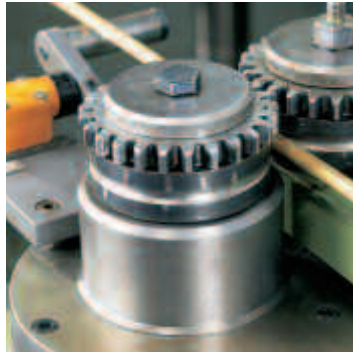

At our parent plant in Amberg, we produce threaded inserts using efficient production methods. A team of qualified and highly motivated staff guarantees a consistent, high standard of production.

The number of products manufactured over the company's history reaches into the billions. State-of-the-art automation lines manufacture around the clock in a precise and high standard of quality. The efficient and low-cost production of large-scale product series is one of the strengths on which we have based our success.

But our high-volume production output in no way compromises flexibility. We are able to quickly and efficiently produce even small batches of non-standard items.

Our state of the art stock control system permits the reliable, prompt delivery of standard products, keeping your production running to schedule at all times and helping to minimize your warehousing costs.

We are particularly proud of a cost-to-performance ratio which ensures satisfied customers the world over. This has made KerbKonus a reputable and respected partner to industry in the global marketplace.

Quality is a top priority issue at KerbKonus. Quality consciousness is a continuous thread running through every aspect of the company's work and all its products and services. Quality is lived and breathed at KerbKonus.

All the most important certifications and approvals are always kept consistently up to date, and our company is audited regularly for compliance with the most important international standards.

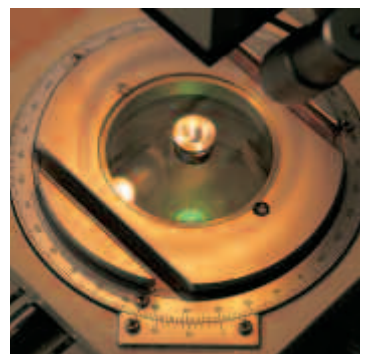

What really counts: tested quality.



Quality System
DQS Certificate in accordance with
DIN EN ISO 9001:2000 Reg. no. 001743 QM
ISO/TS 16949:2002 Reg. no. 001743 TS2/78

Applications on the test stand ...



Threaded inserts from KerbKonus are manufactured in large piece numbers. Human lives and safety can often depend upon these tiny components, for instance in the case of airbag receiving fasteners.

Because we bear this heavy responsibility, our products are tested and monitored in line with the most stringent directives. In the case of particularly critical applications, each and every part is exhaustively tested on state-of-the-art test equipment before it is delivered to you.

Test methods

The loading capacity of a thread depends primarily on the surface shell of the component which is exposed to shearing stress.

By selecting just the right threaded insert for each application, maximum reliability can be achieved.

Using tried and tested, practically oriented test methods (see the table below), we provide the designer with a set of reliable specifications to ensure safe, reliable compliance with any application requirement, however unusual. In most cases, this can even be achieved using standard threaded inserts.

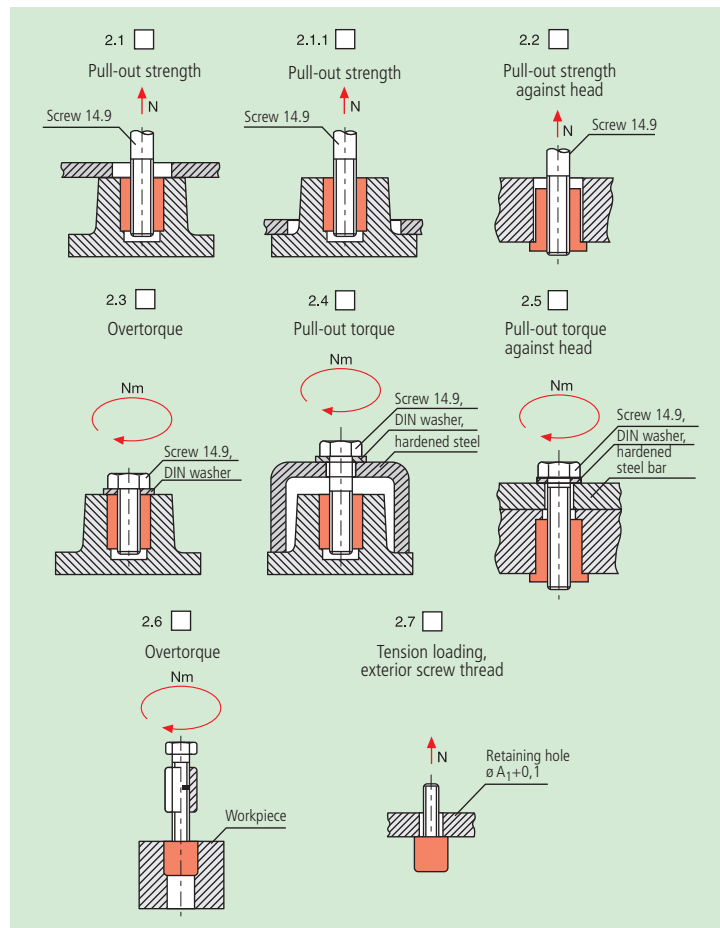



The Ensat® self-tapping threaded insert ...

Ensats® are self-tapping threaded inserts with external and internal threads, cutting slots or cutting bores.

A continuous process of further development has brought about a number of major improvements to product characteristics. These inserts are protected by German and also foreign patents. The Ensat is screwed into a pre-formed or pre-drilled receiving hole and so automatically taps its own thread into the hole wall. This ensures a backlash-free fit with extreme loading capacity.

Ensats® 305 is a thread forming insert with 3 longitudinal grooves around its periphery

Fields of application

The Ensat is used throughout the whole of the metal and plastics processing industry.

Automotive industry

A wide range of supply parts such as wing mirrors, engines, transmissions

Household appliance and office machinery production

Vacuum cleaners, cameras, sun lamps, drills etc.

Electrical and laboratory supplies

Capacitors, radio and telecommunication systems, dental technology equipment.

Plant and equipment construction

Flange connections etc.

Sports equipment

Tennis rackets, ski bindings etc.

Product features

- Universal application for all types of plastic, thermoset plastics, thermoset plastics, PU/PUR foam, fibreglass reinforced plastics, for hardwood and plywood, hard paper and metal.
- Maximum strength values in comparison to other systems. The diagram illustrates the withdrawing force in thermoplastic materials: In thermoset plastics and glass fibre reinforced plastics, the values tend to be higher.
- Thin-walled Ensats for restricted space conditions (residual wall thicknesses), and also suitable for screwing in using a thread tapping machine (same inside and outside pitch).

Slot version WN 303
Three-hole version WN 347/348
page 11

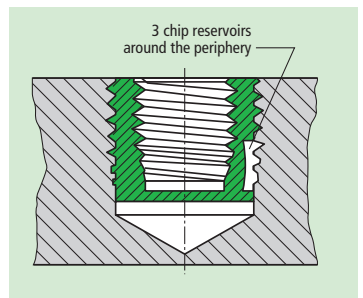
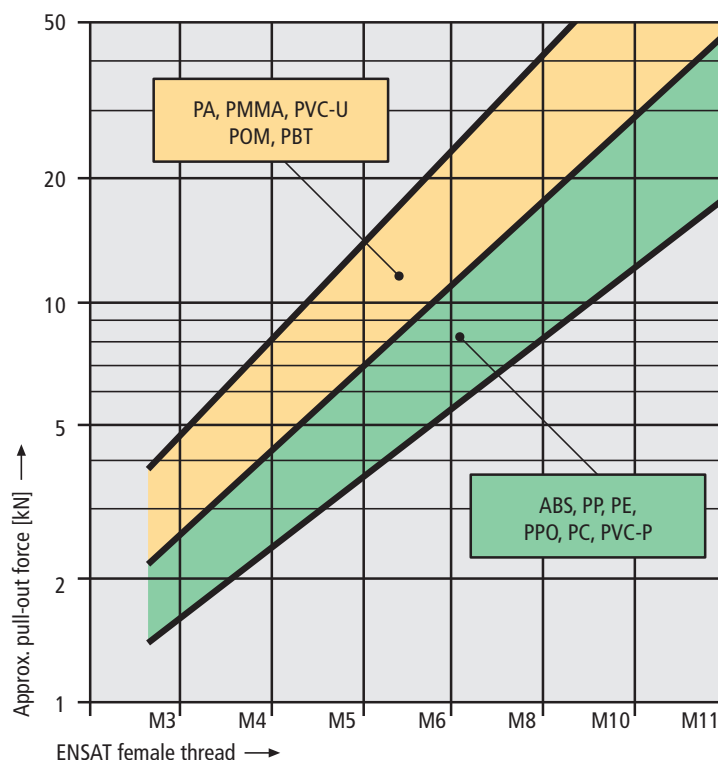

Ensats®-SBS 337/338

These cutting bores are shaped to serve as chip reservoirs. The chips created during the driving process are stored here and cannot drop into sensitive equipment parts.

For additional sealing from below: Ensats with closed floor: Works standard 357/358

Dimensions:

See works standard 307/308, Page 10

The Ensat® in the workpiece ...

Installation recommendation

Avoid any tilting between the Ensat and the screw – under the head or in the thread. For this reason, in the case of adjusting screws the Ensat is driven in to a depth of ≥ 1 mm. Studs must be fixed against the floor surface of the blind hole (see illustration).

Receiving hole

The receiving hole can be simply drilled or already provided for in the casting.

It is generally not necessary to countersink the hole. However, we do recommend that you take care not to warp the workpiece surface when screwing in the Ensat.

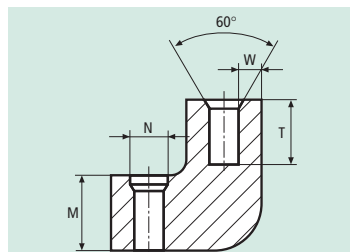

Design of moulded part and receiving hole

Material thickness:

Smallest admissible material thickness \geq length of the Ensat.

Depth of the blind hole T:

see Works Standard sheets, page 8 to 27

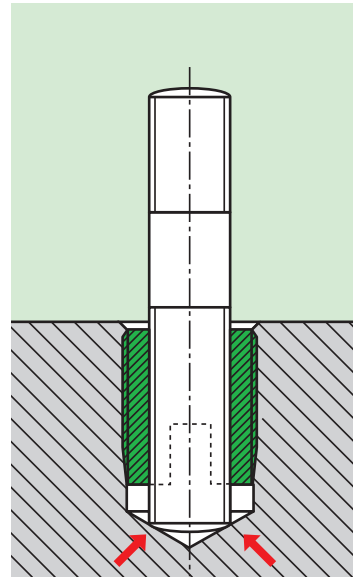

Borehole diameter

Brittle, tough and hard materials call for a larger borehole than soft or elastic materials. For guideline values, see the table above.

Edge distance

The smallest still admissible edge distance depends on the planned stress level and the elasticity of the material into which the Ensat is screwed.

Guideline values for plastic:

$$W \geq 0.25 \text{ to } 0.9 E$$

Sinking the receiving hole

For a clean fit of the Ensat flush with the surface, the following injection or pressed hole form is recommended: Chamfer soft to medium-hard plastics to 60°. For hard and brittle plastics: Pre-inject or pre-press with $N = E + 0.2$ to 0.4 mm.

Sinking depth $X \geq$ pitch of the Ensat male thread.

In moulded parts made of glass fibre reinforced plastic, a high pull-out resistance is reached if the casting skin is removed in the receiving hole by drilling open.

Avoid any tilting between the Ensat and the screw – under the head or in the thread. For this reason, in the case of adjusting screws the Ensat is driven in to a depth of ≥ 1 mm. Studs must be fixed against the floor surface of the blind hole.

Example

Female thread M8, recommended borehole diameter for

Ensat®-S 302:

10.9 to 11.2 mm

Ensat®-S 307/308:

11.1 to 11.3 mm

(see Works Standard sheets)

In case of processing problems (e.g. extreme screw-in torque levels), it is generally of no consequence to choose the next highest column for the diameter data. In case of doubt, it is worth testing this.

The correct length of the stud for the Ensat with cutting slot / cutting bore results from the pitch of the outside thread (see also illustration below; P=pitch of the outside thread).

Ensat® – driving tools ...

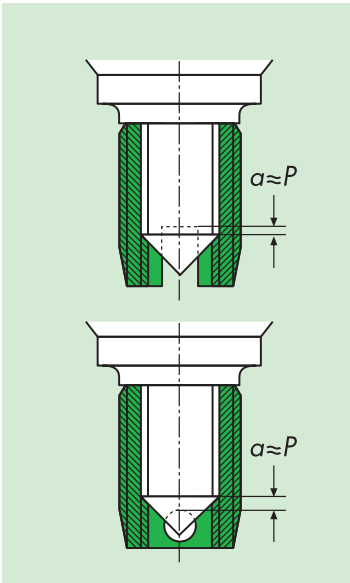

Tool 620 for flush installation

- Square flat
- 1 Shaft
- 4 Pin
- 9 Ball
- 5 Locking screw
- Colour marking
- 6 Ball bearing
- 2 Shell
- 3 Guide bush
- 7 Stud

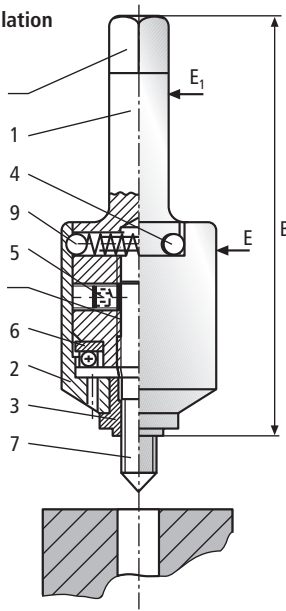

Tool 621 For deep receiving holes

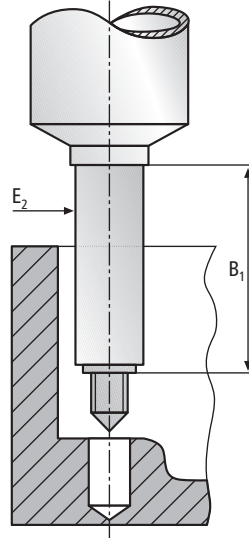

Tool 610 for manual installation

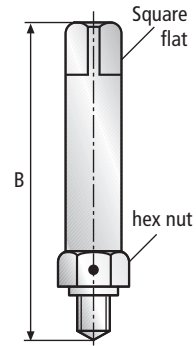

Tool 6102 for Ensat-SBI

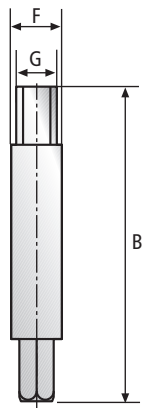

Set or exchange the stud

- Pull off the shell (2) downwards off the shaft (1).
- Release the locking screw (5).
- Screw the stud (7) in or out. Yellow colour marking indicates the flattened surfaces for the locking screws.

- When assembling, tighten both screws (5) evenly.
- Insert the ball bearing (6).
- Push on the shell (2) until the ball stop locks into place. To ensure that the tool functions

perfectly, it must be possible to easily rotate the shell. For short Ensats, grind down tool 610 accordingly.

- If you wish the Ensat to be driven deeper than 0.2 mm below the workpiece surface, screw off the guide bush (3) at the front.

Diameter: 0.1 to 0.2 mm smaller than the Ensat receiving hole.

For mounting the thin-walled Ensat (Page 11), modified guide bushes should be used. (available on request)

Dimensions [mm]

For Ensat	Tool 620				Tool 621				Manual assembly tool				For Ensat-SBI	Tool 6102 Machine/Hand						
	Article-no.	Whitwort	UNC	UNF	E	E ₁	Square SW D	Length B	Article-no.	B ₁	E ₂	Article-no.		Length B	Square SW D	Collar Sw D	Article-no.	Length B	Square SW G	Shank Ø F
M 2,5	-	620 000 025	-	-	18	8	6,3	78	621 000 025	40	7	610 000 025	55	5	7	M 2,5	-	-	-	-
M 3	Nr. 4	620 000 030	-	620 000 604	18	8	6,3	78	621 000 030	40	7	610 000 030	55	5	7	M 3	-	-	-	-
M 3,5	Nr. 6	620 000 035	-	620 000 606	18	8	6,3	78	621 000 035	40	7	610 000 035	60	5	7	M 3,5	-	-	-	-
M 4	Nr. 8	620 000 040	-	620 000 608	18	8	6,3	78	621 000 040	40	7	610 000 040	60	5	7	M 4	610 200 040	80	4,9	6
M 5	Nr. 10	620 000 050	-	620 000 610	24	12,5	10	95	621 000 050	50	9	610 000 050	75	8	13	M 5	610 200 050	90	6,2	8
M 6	1/4"	620 000 060	620 000 525	620 000 625	24	12,5	10	95	621 000 060	50	10	610 000 060	75	8	13	M 6	610 200 060	100	8	10
M 8	5/16"	620 000 080	620 000 531	620 000 631	24	12,5	10	95	621 000 080	50	12	610 000 080	75	8	13	M 8	610 200 080	100	8	10
M 10	3/8"	620 000 100	620 000 537	620 000 637	32	16	12,5	118	621 000 100	60	15	610 000 100	95	12,5	19	M 10	610 200 100	110	9	12
M 12	7/16"	620 000 120	620 000 544	620 000 644	32	16	12,5	118	621 000 120	60	18	610 000 120	95	12,5	19	M 12	-	-	-	-
M 14	1/2"	620 000 140	620 000 550	620 000 650	50	25	20	145	621 000 140	60	20	610 000 140	95	12,5	19	M 14	-	-	-	-
M 16	5/8"	620 000 160	620 000 562	620 000 662	50	25	20	145	621 000 160	60	22	-	-	-	M 16	-	-	-	-	
M 18	-	620 000 180	-	-	50	25	20	145	621 000 180	60	24	-	-	-	M 18	-	-	-	-	
M 20	-	620 000 200	-	-	58	25	20	169	621 000 200	60	26	-	-	-	M 20	-	-	-	-	
M 22	-	620 000 220	-	-	58	25	20	169	621 000 220	60	28	-	-	-	M 22	-	-	-	-	
M 24	-	620 000 240	-	-	70	30	25	198	621 000 240	60	32	-	-	-	M 24	-	-	-	-	
M 27	-	620 000 270	-	-	70	30	25	198	621 000 270	60	35	-	-	-	M 27	-	-	-	-	
M 30	-	620 000 300	-	-	70	30	25	198	621 000 300	60	38	-	-	-	M 30	-	-	-	-	

Tools 620 and 621 also fit within the coloured lines for other thread dimensions, if the guide bush and stud are exchanged

Machine installation ...

Machine driving process

1. Precisely position the workpiece to ensure that the hole and machine spindle are in exact alignment (do not tilt). Set the machine to the precise driving depth (appr. 0.1 – 0.2 mm below the surface of the workpiece).
2. Turn the machine to clockwise rotation. At the start of the driving process, the rotatable external shell of the tool must be resting against the external visible stop pins in such a way that it is driven by the pins in the clockwise direction.
3. Feed the Ensat towards the tool (**slot or cutting bore facing downwards**) and grip for the duration of 2 to 4 revolutions.
4. Actuate the operating lever of the machine until the Ensat cuts into the borehole. The remainder of the driving process takes place without actuating the feed.
5. Switch on the reversing function. Always avoid setting the tool down hard on the workpiece, as this can lead breaking of both the tool and the Ensat. Excessively hard contact of the tool can damage the play-free fit of the Ensat and so reduce the pull-out strength. If necessary, the driving speed may have to be adapted in line with the necessary reversal time.



Machine installation takes place with production tool 620 or 621, integrated in a:

- **Thread tapping machine**
 - Use a **drill press** fitted with a reversing tapping attachment or a tapping machine which is not pitch controlled. Important: Never exceed the maximum admissible driving torque.
 - **Special manual machine** with bit stop and reversing system.
 - **Single or multiple installation machines** with pneumatic or electric drive, semi or fully automatic, CNC.
- For large-scale series:

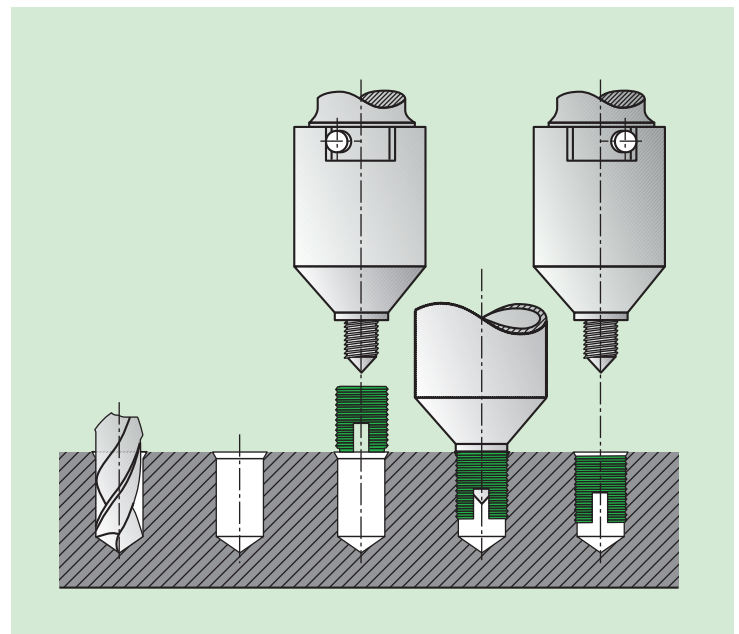

Torque M

The maximum admissible torque depends on:

1. The axial load capacity of the tool stud
2. The pressure resistance capacity of the Ensat in the axial direction.

Maximum admissible installation torque

Ensats® M 2,5	1,5 Nm
Ensats® M 3	2,5 Nm
Ensats® M 4	5,5 Nm
Ensats® M 5	10 Nm
Ensats® M 6	15 Nm
Ensats® M 8	28 Nm
Ensats® M 10	40 Nm
Ensats® M 12	60 Nm

Recommended speed values for plastic:

Ensats® Internal thread	Speed [min ⁻¹]
M 2,5 / M 3	800 - 1300
M 4 / M 5	600 - 900
M 6 / M 8	400 - 700
M 10 / M 12	300 - 450
M 14 / M 16	240 - 350
M 18 / M 20	180 - 300
M 22 / M 24	160 - 250
M 27 / M 30	140 - 200

Application

The threaded insert with cutting slot is a self-tapping fastener for the creation of wear-free, vibration resistant screw joints with high loading capacity in materials with low shearing strength.

It is suitable for installation in the following materials:

- Plastic, laminates
- Hardwood, but also
- Light alloys
- Cast iron, brass, bronze
- NF metals

For technical information see Publication 20

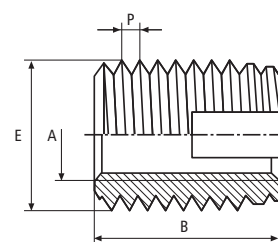

Dimensions in mm

Article no.	Internal thread A	External thread		Length B	Guideline values for receiving hole dia. L	Minimum drill hole depth in case of blind holes T
		E	P			
302 000 020 ...	M 2	4,5	0,5	6	4,1 to 4,2	8
302 000 025 ...	M 2,5	4,5	0,5	6	4,1 to 4,2	8
302 000 030 ...	M 3	5	0,5	6	4,6 to 4,7	8
302 000 035 ...	M 3,5	6	0,75	8	5,5 to 5,6	10
302 000 040 ...	M 4	6,5	0,75	8	6,0 to 6,1	10
302 000 050 ...	M 5	8	1	10	7,3 to 7,5	13
302 000 061 ...	M 6 (a)	9	1	12	8,3 to 8,5	15
302 000 060 ...	M 6	10	1,5	14	8,9 to 9,2	17
302 000 080 ...	M 8	12	1,5	15	10,9 to 11,2	18
302 000 100 ...	M 10	14	1,5	18	12,9 to 13,2	22
302 000 120 ...	M 12	16	1,5	22	14,9 to 15,2	26
302 000 140 ...	M 14	18	1,5	24	16,9 to 17,2	28
302 000 160 ...	M 16	20	1,5	22	18,9 to 19,2	27
302 000 180 ...	M 18	22	1,5	24	20,9 to 21,2	29
302 000 200 ...	M 20	26	1,5	27	24,9 to 25,2	32
302 000 220 ...	M 22	26	1,5	30	24,9 to 25,2	36
302 000 240 ...	M 24	30	1,5	30	28,9 to 29,2	36
302 000 270 ...	M 27	34	1,5	30	32,9 to 33,2	36
302 000 300 ...	M 30	36	1,5	40	34,9 to 35,2	46

Example for finding the article number

Self-tapping threaded insert Ensat-S of Works Standard series 302 with internal thread A = M5 made of steel, hardened, zinc-plated and yellow chromated: Ensat-S 302 000 050.160

Materials

- Unhardened steel
- Case-hardened steel, zinc-plated, yellow chromated
- Brass
- Rust-proof steel 1.4105
- Rust-proof steel 1.4305
- Other materials, designs and finishes on request.

- Article no. 100
- Article no. 160
- Article no. 800
- Article no. 400
- Article no. 500

Tolerances

ISO 2768-m

Thread

Internal thread A: as per ISO 6H
External thread E: metric, tolerances in accordance with works standard
Internal thread UNC, UNF, Whitworth, see page 9

Remark:

M2/M2.5 only for materials with minimal strength, as the shearing resistance of the studs in the installation tools may be insufficient.



Threaded insert
self-tapping
imperial thread

Ensat®-S
Works Standard
302

Application

Threaded insert with cutting slot and Whitworth, UNC or UNF internal thread.

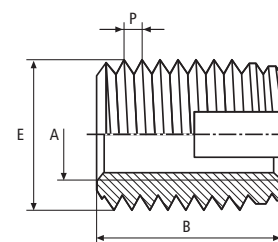

Dimensions in mm

	Article no.	Internal thread inch	External thread mm		Length mm	Guideline values for receiving hole dia.	Minimum drill hole depth in case of blind holes
		A	E	P	B	L	T
Whitworth B.S.84 Internal thread tolerance class medium	302 000 525 ...	1/4	10	1,5	14	8,9 to 9,2	17
	302 000 531 ...	5/16	12	1,5	15	10,9 to 11,2	18
	302 000 537 ...	3/8	14	1,5	18	12,9 to 13,2	22
	302 000 544 ...	7/16	16	1,5	22	14,9 to 15,2	26
	302 000 550 ...	1/2	18	1,5	22	16,9 to 17,2	26
302 000 562 ...	5/8	20	1,5	22	18,9 to 19,2	27	
UNC Unified Coarse Thread ANSI B1.1/BS 1580 Internal thread tolerance class 2B	302 000 604 ...	4 - 40	5	0,5	6	4,6 to 4,7	8
	302 000 606 ...	6 - 32	6	0,75	8	5,5 to 5,6	10
	302 000 608 ...	8 - 32	6,5	0,75	8	6,0 to 6,1	10
	302 000 610 ...	10 - 24	8	1	10	7,3 to 7,5	13
	302 000 625 ...	1/4 - 20	10	1,5	14	8,9 to 9,2	17
	302 000 631 ...	5/16 - 18	12	1,5	15	10,9 to 11,2	18
	302 000 637 ...	3/8 - 16	14	1,5	18	12,9 to 13,2	22
	302 000 644 ...	7/16 - 14	16	1,5	22	14,9 to 15,2	26
	302 000 650 ...	1/2 - 13	18	1,5	22	16,9 to 17,2	28
302 000 662 ...	5/8 - 11	20	1,5	22	18,9 to 19,2	27	
UNF Unified Fine Thread ANSI B1.1/B 1580 Internal thread tolerance class 2B	302 000 704 ...	4 - 48	5	0,5	6	4,6 to 4,7	8
	302 000 706 ...	6 - 40	6	0,75	8	5,5 to 5,6	10
	302 000 708 ...	8 - 36	6,5	0,75	8	6,0 to 6,1	10
	302 000 710 ...	10 - 32	8	1	10	7,3 to 7,5	13
	302 000 725 ...	1/4 - 28	10	1,5	14	8,9 to 9,2	17
	302 000 731 ...	5/16 - 24	12	1,5	15	10,9 to 11,2	18
	302 000 737 ...	3/8 - 24	14	1,5	18	12,9 to 13,2	22
	302 000 744 ...	7/16 - 20	16	1,5	22	14,9 to 15,2	26
	302 000 750 ...	1/2 - 20	18	1,5	22	16,9 to 17,2	28
302 000 762 ...	5/8 - 18	20	1,5	22	18,9 to 19,2	27	

Example for finding the article number

Self-tapping threaded insert Ensat-S of Works Standard series 302 with internal thread UNF 1/4"-28 made of steel, hardened, zinc-plated and yellow chromated: Ensat-S 302 000 725.160

Materials

Unhardened steel
Case-hardened steel, zinc-plated, yellow chromated
Brass
Rust-proof steel 1.4105
Rust-proof steel 1.4305
Other materials, designs and finishes on request.

Article no. 100
Article no. 160
Article no. 800
Article no. 400
Article no. 500

Tolerances

ISO 2768-m

Thread

External thread E: metric, Tolerances in accordance with Works Standard

Application

Threaded insert Ensat-SB with cutting bores is a self-tapping fastener for the creation of wear-free, vibration resistant screw joints with high loading capacity in materials with low shearing strength.

It is suitable for installation in the following materials:
 - Duroplastics, thermoset plastics (with the exception of rubber-soft thermoset plastics < 100 Shore A)
 but also for

- Aluminium and aluminium alloys
 - Magnesium alloys
 Technical information is provided in publication 20

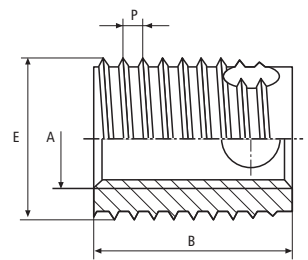

Dimensions in mm

Article no.	Internal thread A	External thread		Length B	Receiving hole dia. for plastics (guideline values) L	Minimum drill hole depth in case of blind holes T
		E	P			
307 000 030 ... 308 000 030 ...	M 3	5	0,6	4 6	4,6 to 4,7	6 8
307 000 035 ... 308 000 035 ...	M 3,5	6	0,8	5 8	5,5 to 5,6	7 10
307 000 040 ... 308 000 040 ...	M 4	6,5	0,8	6 8	6,0 to 6,1	8 10
307 000 050 ... 308 000 050 ...	M 5	8	1	7 10	7,4 to 7,6	9 13
307 000 060 ... 308 000 060 ...	M 6	10	1,25	8 12	9,3 to 9,5	10 15
307 000 080 ... 308 000 080 ...	M 8	12	1,5	9 14	11,1 to 11,3	11 17
307 000 100 ... 308 000 100 ...	M 10	14	1,5	10 18	13,1 to 13,3	13 22
307 000 120 ... 308 000 120 ...	M 12	16	1,75	12 22	15,0 to 15,2	15 26
307 000 140 ... 308 000 140 ...	M 14	18	2	14 24	17,0 to 17,2	17 28
307 000 160 ... 308 000 160 ...	M 16	20	2	14 24	19,0 to 19,2	17 28

Example for finding the article number

Self-tapping threaded insert Ensat-SB from Works Standard series 307 with internal thread A = M5 made of hardened, zinc-plated and yellow chromated steel: Ensat-SB 307 000 050.160

Short design Long design

Works Standard 307
 Works Standard 308

Materials

Unhardened steel
 Case-hardened steel, zinc-plated, yellow chromated
 Rust-proof steel 1.4105
 Rust-proof steel 1.4305
 Brass
 Other materials, designs and finishes on request.

Article no. 100
 Article no. 160
 Article no. 400
 Article no. 500
 Article no. 800

Tolerances

ISO 2768-m

Thread

Internal thread A: as per ISO 6H
 External thread E: Special thread with flattened thread root, tolerances in accordance with Works Standard
 Internal thread UNC, UNF, Whitworth or fine thread on request

Special applications

For chip-sensitive applications (e.g. electronic appliances): Also available with 3 closed cutting holes serving as chip reservoirs.



Thin-walled threaded insert
self-tapping, cutting slot

Ensat®-SD
Works Standard 303

Application

Threaded insert Ensat with cutting slot in a special thin-walled and shortened version. Particularly suitable for plastic with thin residual walls and for light-weight constructions.

These versions are designed primarily for processing on thread tapping machines, as the pitch of the outside and internal thread is identical.

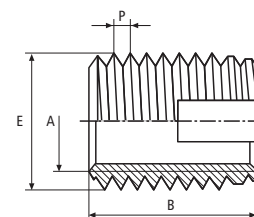

Dimensions in mm

Article no.	Internal thread A	External thread		Length B	Guideline values for receiving hole dia.		Minimum drill hole depth in case of blind holes T
		E	P		Soft plastics, hardwood L	Hard, brittle plastics L	
303 000 030 ...	M 3	4,5	0,5	6	4,0 to 4,1	4,1 to 4,2	8
303 000 035 ...	M 3,5	5	0,6	6	4,5 to 4,6	4,6 to 4,7	8
303 000 040 ...	M 4	6	0,7	6	5,3 to 5,4	5,5 to 5,6	8
303 000 050 ...	M 5	7	0,8	8	6,3 to 6,4	6,5 to 6,6	10
303 000 060 ...	M 6	8	1,0	10	7,1 to 7,2	7,3 to 7,5	13
303 000 080 ...	M 8	10	1,25	12	8,6 to 8,8	8,9 to 9,2	15
303 000 100 ...	M 10	12	1,5	15	10,6 to 10,8	10,9 to 11,2	18

Example for finding the article number

Self-tapping thin-walled insert Ensat-SD slot from Works Standard series 303 with internal thread A = M5 made of hardened, zinc-plated and yellow chromated steel: Ensat-SD 303 000 050.160

Materials, tolerances, thread see Works Standard 302, Page 8 and 9



Thin-walled threaded insert
Self-tapping, cutting bore

Ensat®-SBD
Works Standard 347/348

Application

Threaded insert Ensat with three cutting bores in a special thin-walled and shortened version. Particularly suitable for plastic with thin residual walls and for light-weight constructions. These versions are designed prima-

rily for processing on thread tapping machines, as the pitch of the outside and internal thread is identical. For processing thin-walled inserts in metals, the tensile strength / hardness of the base material is the determining factor.

In critical cases, lubrication using suitable means is recommended in order to prevent breakage of the thin-walled inserts.

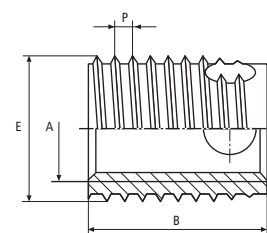

Dimensions in mm

Article no.	Internal thread A	External thread		Length B		Receiving hole dia. for plastics (guideline values) L	Minimum drill hole depth T (blind holes) Works standard	
		E	P	Works standard			B	B
3.. 000 035 ...	M 3,5	5	0,6	5	8	4,6 to 4,7	7	10
3.. 000 040 ...	M 4	6	0,7	6	8	5,4 to 5,6	8	10
3.. 000 050 ...	M 5	6,5	0,8	7	10	6,0 to 6,1	9	13
3.. 000 060 ...	M 6	8	1	8	12	7,4 to 7,6	10	15
3.. 000 080 ...	M 8	10	1,25	9	14	9,3 to 9,5	11	17
3.. 000 100 ...	M 10	12	1,5	10	18	11,1 to 11,3	13	22
3.. 000 120 ...	M 12	14	1,75	12	22	13,1 to 13,3	15	26
3.. 000 140 ...	M 14	16	2	14	24	15,0 to 15,2	17	28
3.. 000 160 ...	M 16	18	2	14	24	17,0 to 17,2	17	28

Short design

Works Standard 347

Long design

Works Standard 348

Materials, tolerances, thread

see Works Standard 307/308, Page 10

Application

Threaded insert Ensats 309 with cutting slot is a fastener designed to create wear- and vibration-resistant screw connections capable of withstanding high loads in:

- Hardwood
- Softwood
- Soft plastic and Composite materials

Installation

- 1. Self-tapping**
Installation with cutting slot facing **down** (normal application)
- 2. Thread forming**
Installation with cutting slot facing **up** (in very soft materials)
- 3. With internal hexagon thread (M4 to M10):**
For installation information please see page 14.

Ensats SH 309

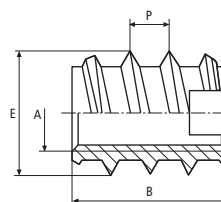

Ensats SHI 309 2

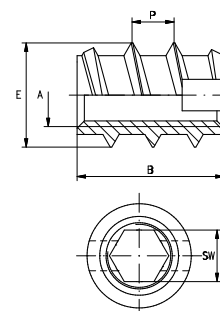

Dimensions in mm

Article no.	Internal thread A	External thread Special thread		Length B	Hexagonal socket SW +0,1	Guideline values for receiving hole dia.		Minimum drill hole depth (blind holes) T
		E	P			Softwood ≥ L	Plastic Hardwood L	
309 000 025 ...	M 2,5	5	1,6	6	—	3,5	3,6 to 3,8	8
309 000 030 ...	M 3	5,5	1,6	6	—	4,1	4,2 to 4,3	8
309 000 035 ...	M 3,5	6,5	1,6	8	—	4,6	4,7 to 4,8	10
309 000 040 ... 309 200 040 ...	M 4	7	2,5	10	3,2	5,1	5,2 to 5,3	13
309 000 050 ... 309 200 050 ...	M 5	9	3	12	4,1	6,6	6,7 to 6,9	15
309 000 060 ... 309 200 060 ...	M 6	10	4	14	4,9	7,6	7,7 to 7,9	17
309 000 080 ... 309 200 080 ...	M 8	13	4	20	6,6	9,9	10,1 to 10,3	23
309 000 100 ... 309 200 100 ...	M10	16	5	23	8,3	12,4	12,6 to 12,8	26
309 000 120 ...	M12	19	5	26	10,1	15,4	15,6 to 15,8	30
309 000 140 ...	M14	22	5	26	—	18,4	18,6 to 18,8	30
309 000 160 ...	M16	24	5	26	—	20,4	20,6 to 20,8	30

Example for finding the article number

Self-tapping threaded insert Ensats from Works Standard series 309 with internal thread A = M5 made of brass: Ensats 309 000 050.800

Materials

Unhardened steel
Brass
Other materials, designs and finishes on request.

Article no. 100
Article no. 800

Tolerances

ISO 2768-m

Thread

Internal thread A: as per ISO 6H
External thread E: Wood thread. Tolerances in accordance with the Works Standard



Threaded insert
thread forming

Ensat®-3F
Works Standard
305

Application

For the manufacture of wear-resistant screw fastenings capable of withstanding high loads in plastic, preferably thermosetting plastics.

The outside thread is interrupted by three longitudinal grooves which permit the Ensat 3F-305 to form the thread into the receiving hole.

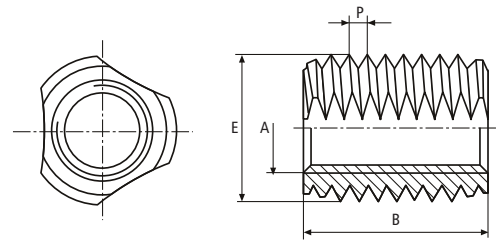

Dimensions in mm

Article no.	Internal thread	External thread		Length	Receiving hole dia. (guideline values)	Minimum drill hole depth (blind holes) T
	A	E	P	B		
305 000 030.800	M 3	5	0,5	6	4,6 to 4,7	7
305 000 040.800	M 4	6,5	0,75	8	6,0 to 6,1	9
305 000 050.800	M 5	8	1	10	7,3 to 7,4	11
305 000 060.800	M 6	10	1,5	14	9,0 to 9,2	15

Example for finding the article number

Self-tapping threaded insert Ensat from Works Standard series 305 with internal thread A = M5 made of brass: Ensat-3F 305 000 050.800

Materials

Brass
Other materials, designs and finishes on request.

Article no. 800

Tolerances

ISO 2768-m

Thread

Internal thread A: as per ISO 6H
External thread E: metric, tolerances in accordance with the Works Standard
Internal thread UNC, UNF, Whitworth on request

Application

This threaded insert with hexagonal socket is a self-tapping fastener for the creation of low-wear, vibration resistant screw joints with high load capacity in materials with low shearing strength. The Ensat is inserted via the hexagonal socket, permitting the achievement of short installation times. Other benefits: More simple driving tools and machines which require only clockwise rotation.

When using in plastics, the Ensat can be extracted without problems before the recycling process, resulting in lower costs. It is suitable for installation in the following materials:

- Duroplastics, thermoplastics (with the exception of rubber-soft thermoplastics < 100 Shore A)
- Aluminium and aluminium alloys
- Magnesium alloys

Ensat SI 302 2

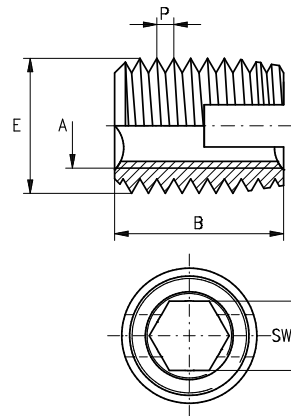

Ensat SBI 307 2 / 308 2

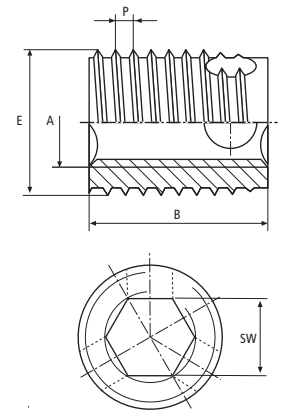

Dimensions in mm

Article no.	Internal thread	Special external thread		Length	Hexagonal socket	Minimum drill hole depth in case of blind holes	Guideline values for receiving hole dia.
	A	E	P				
302 200 040 ... 307 200 040 ... 308 200 040 ...	M 4	6,5	0,75	8	3,2	10	6,0 to 6,1
			0,8	6	3,2	8	
					8		
302 200 050 ... 307 200 050 ... 308 200 050 ...	M 5	8	1	10	4,1	13	7,4 to 7,6
			1	7	4,1	9	
					10		
302 200 060 ... 307 200 060 ... 308 200 060 ...	M 6	10	1,5	14	4,9	17	9,3 to 9,5
			1,25	8	4,9	11	
					12		
302 200 080 ... 307 200 080 ... 308 200 080 ...	M 8	12	1,5	15	6,6	18	11,1 to 11,3
			1,5	9	6,6	12	
					14		
302 200 100 ... 307 200 100 ... 308 200 100 ...	M 10	14	1,5	18	8,3	22	13,1 to 13,3
			1,5	10	8,3	16	
					18		
302 200 120 ... 307 200 120 ... 308 200 120 ...	M 12	16	1,5	22	10,1	27	15,0 to 15,2
			1,75	12	10,1	15	
					22		

Example for finding the article number

Self-tapping threaded insert Ensat-SBI from Works Standard series 308 2 with internal thread A = M 5 made of hardened, zinc-plated, yellow chromated steel: Ensat-SBI 308 200 050.160

Materials

Case-hardened steel, zinc-plated, yellow chromated
Brass
Other materials on request.

Article no. 160
Article no. 800

Tolerance

ISO 2768-m

Thread

Internal thread A: as per ISO 6H
External thread E: Special thread with flattened thread root, tolerance in accordance with Works Standard

Mubux®-A – pressed-in threaded insert/stud ...

The Mubux-A is a threaded insert or stud with multiple helically knurled rings, a tapered anchorage profile and a pilot end for easy embedding.

Field of application

For all moulded parts made of hard plastic.

Product features

- Fast and easy to install.
A special pilot end prevents inser-
tion problems.
- Relatively small diameter and mini-
mal installation length
- Particularly cost-effective

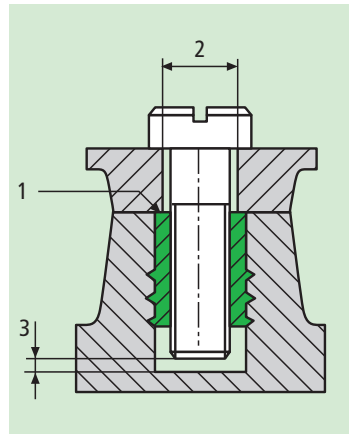

Design of the shaped com- ponent and receiving hole

The part to be fastened must be loca-
ted flush on the threaded insert, see
illustration (1), which in turn requires
the borehole to have narrow dimen-
sions and to sink into the material.
Allow the Mubux-A to project approx.
0.1 mm over the surface of the mould-
ed component (1).

Both plastic parts must lock into place
for maximum torque safety to prevent
the occurrence of a breakaway levering
effect.

Hole diameter and wall thicknesses
are dependent on the material used
for the formed part. Please enquire or
ascertain by testing. For guideline
values, see the works standard sheets.

Hole depth

≥ Length of the Mubux-A + 1mm.
The screw must not under any circum-
stances come to rest at the bottom of
the hole.

Available designs:

- Standard length.
- Short length.
- Contact head for electrical contacts or
for simultaneous fixture of several
parts.
- Stud with and without support head.

Installation

Insert the Mubux-A with pilot start
downwards into the receiving hole
and press in with the hand lever or a
small press. Never knock in Mubux-A
with a hammer!

Mubux-A achieves outstanding pull-
out resistance if inserted into moulded
components immediately after removal
from the mould, when the component
has not yet fully cooled down.

Mubux-A has also proven successful in
some duroplastic materials if embed-
ded using ultrasound technology.

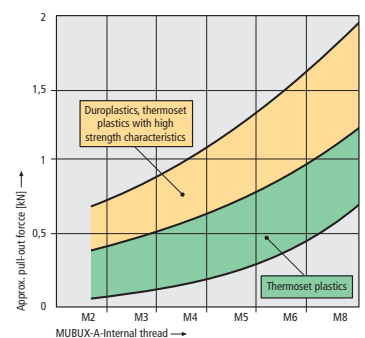

All table values apply only if the screw
is inserted to at least 50% of its
length in the threaded insert.



Application

For the manufacture of wear-resistant screw fasteners with high loading capacity in hard plastic.

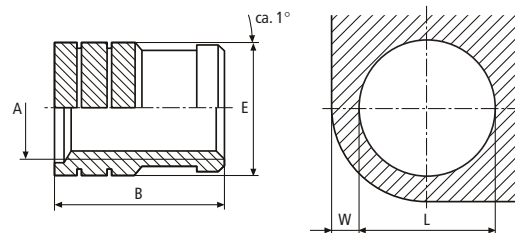

Dimensions in mm

Article no.	Internal thread A	External dia. E	Length B	Minimum wall thickness W	Hole dia. (guideline values) L
850 000 020.800	M 2	3,35	4,0	1,6	3,1
850 000 025.800	M 2,5	4,2	5,3	2,0	3,8
850 000 030.800	M 3	4,2	5,3	2,0	3,8
850 000 035.800	M 3,5	5,0	6,3	2,5	4,6
850 000 040.800	M 4	5,8	7,4	2,5	5,4
850 000 050.800	M 5	6,6	8,3	2,5	6,2
850 000 060.800	M 6	8,2	9,2	2,8	7,8
850 000 080.800	M 8	9,7	9,2	3,8	9,3
850 000 100.800	M 10	12,0	9,2	5,5	11,6

Example for finding the article number

Pressed-in threaded insert Mubux®-A from Works Standard 850 with internal thread A = M 4 made of brass: Mubux-A 850 000 040.800

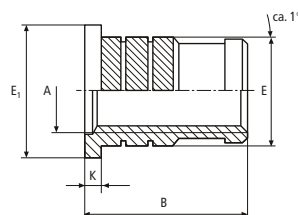

Dimensions in mm

Article no.	Internal thread A	External dia. (excluding head) E	Head dia. E ₁	Head height K	Length B
852 000 020.800	M 2	3,35	4,8	0,6	4,6
852 000 025.800	M 2,5	4,2	5,6	0,6	5,9
852 000 030.800	M 3	4,2	5,6	0,6	5,9
852 000 035.800	M 3,5	5,0	6,4	0,8	7,1
852 000 040.800	M 4	5,8	7,2	0,8	8,2
852 000 050.800	M 5	6,6	8,0	1,0	9,3
852 000 060.800	M 6	8,2	9,5	1,3	10,5
852 000 080.800	M 8	9,7	11,0	1,3	10,5
852 000 100.800	M 10	12,0	14,0	1,6	10,8

For receiving hole diameter, see article no. 850

Material

Brass

Article no. 800

Tolerances

ISO 2768-m

Thread

as per ISO 6H



Pressed-in threaded studs

Mubux®-AS
Works Standard
856

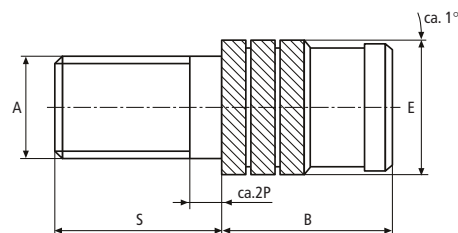

Available stud lengths
(other lengths on request) Dimensions in mm

Article no.	Thread	External dia.	insert length
	A	E	B
856 000 020.8..	M 2	3,35	4,0
856 000 025.8..	M 2,5	4,2	5,3
856 000 030.8..	M 3	4,2	5,3
856 000 035.8..	M 3,5	5,0	6,3
856 000 040.8..	M 4	5,8	7,4
856 000 050.8..	M 5	6,6	8,3
856 000 060.8..	M 6	8,2	9,2
856 000 080.8..	M 8	9,7	9,2

Article no. (eleventh digit)	Length S	Available		
		M 2 M 2,5	M 3 M 3,5 M 4	M 5 M 6 M 8
... .. .20	6	X	X	X
... .. .40	10	X	X	X
... .. .60	16	X	X	X
... .. .80	25	X	X	X

Thread length = S - 2P
P = Thread pitch

For receiving hole diameter, see article no. 850...

Example for finding the article number

Pressed-in threaded insert Mubux®-A from Works Standard 856, length of the threaded stud S = 10 mm made of brass: Mubux-A 856 000 040.840



Pressed-in threaded studs

Mubux®-ASK
Works Standard 857

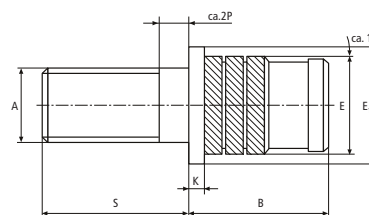

Dimensions in mm

Article no.	Thread	External dia. (excluding head)	Head dia.	Head height	Length
	A	E	E ₁	K	B
857 000 020.8..	M 2	3,35	4,8	0,6	4,6
857 000 025.8..	M 2,5	4,2	5,6	0,6	5,9
857 000 030.8..	M 3	4,2	5,6	0,6	5,9
857 000 035.8..	M 3,5	5,0	6,4	0,8	7,1
857 000 040.8..	M 4	5,8	7,2	0,8	8,2
857 000 050.8..	M 5	6,6	8,0	1,0	9,3
857 000 060.8..	M 6	8,2	9,5	1,3	10,5
857 000 080.8..	M 8	9,7	11,0	1,3	10,5

Available stud lengths: See table

For the receiving hole diameter, see article no. 850

Material

Brass

Article no. 800

Tolerances

ISO 2768-m

Thread

as per ISO 6H



B-Lok[®] self-locking threaded insert

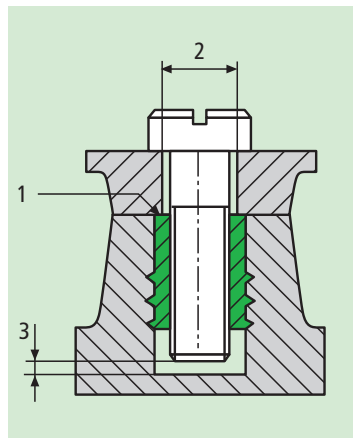

The B-Lok is a threaded insert with different external profiles, which guarantee optimum anchorage in all types of moulded plastic components

Product features

- Unbeatably short installation times
- Screw is secured automatically against loosening
- Cost savings for locking elements

B-Lok[®]
Registered Trademark
GB No. 2 314 786
USA No. 2,002,588
J No. 3 150 190

Selection of the correct B-Lok type:

Material	B-Lok	Works Standard	Page
Thermoset plastic	-MV or -E	812/815, 830/831	19, 20
Duroplastic	-R	841	21
PU/PUR-foam	-R, -MV or -E	841, 812/815 830/831	21, 19, 20
Wood	-F or -E	821/823, 830/831	20
Through holes in laminate materials or side walls	-RK	842	21

We recommend practical testing.

All table values apply only if the screw is inserted to at least 50% of its length in the threaded insert.

Design of the moulded component and receiving hole

The part requiring fastening should be flush with the threaded insert, see (1). For this reason, the borehole (2) should be closely dimensioned and not countersunk. The B-Lok can be left projecting above the surface of the moulded component by appr. 0.1 mm.

Both plastic parts must lock into place for maximum torque safety to prevent the occurrence of a breakaway levering effect.

The screw length must be selected so that the B-Lok is completely expanded.

Hole diameter and wall thicknesses are dependent on the material used for the formed part. Please enquire or ascertain by testing. For guideline values, see the works standard sheets. Conicity max. +0.04 mm. For B-Lok, we recommend the smallest possible hole diameter in which it is still possible to reliably insert the screw. Although a larger hole means that the screw is less stiff running, at the same time reduces pull-out resistance and torque safety.

Hole depth. This should be overdimensioned if possible. The screw must not under any circumstances come to rest at the bottom of the hole, see (3).

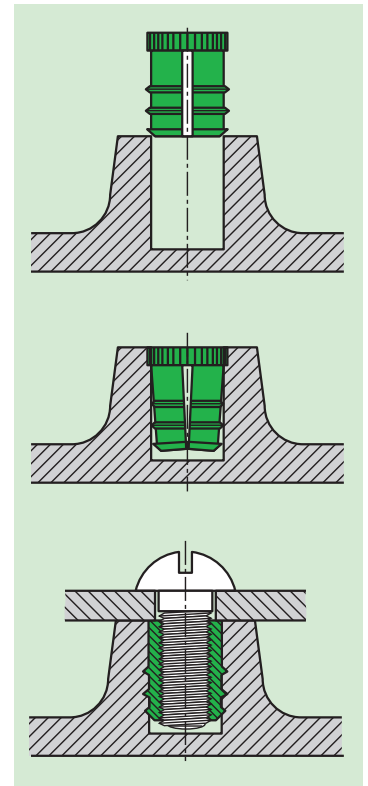

Installation

1. The B-Lok is pressed into the receiving hole, during which process the segments bend inwards.
2. When inserting the screw, the segments resume their original shape, in which process the external profile becomes anchored in the hole wall. The residual tension acts to lock the screw in place.

In the case of small-scale series, the B-Lok is embedded with a simple manual levering device (possibly a small press or drill at a standstill).

For large series: Single or multiple installation machines on request.

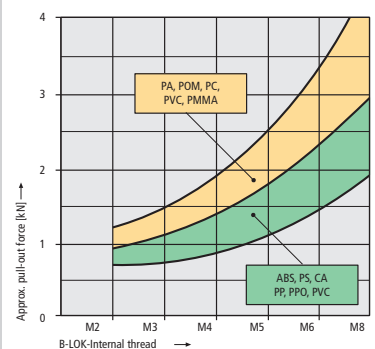



Expansion inserts
self-locking

B-Lok®-MV
Works Standard
812 bis 815

Application

For creation of wear and vibration-resistant screw fastenings with high load capacity in plastic moulded components, preferably thermoset plastic. The insert is anchored in the moulded component by precision anchoring

vanes, and torque safety is provided by a gear ring. The screw is rendered resistant to vibration by the clamping action of the two segments.

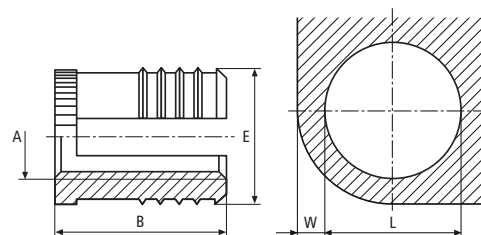

Dimensions in mm

Article no.	Internal thread A	External dia. E	Length B	Number of vanes	Minimum wall thickness W	Hole dia. (guideline values) L
812 000 020.800	M 2	3,45	4,0	2	1,6	3,2
813 000 025.800	M 2,5	4,3	4,8	3	2,0	4,0
813 000 030.800	M 3	4,3	4,8	3	2,0	4,0
813 000 035.800	M 3,5	5,1	6,4	3	2,4	4,8
814 000 040.800	M 4	5,9	8,0	4	2,8	5,6
815 000 050.800	M 5	6,7	9,5	5	3,2	6,4
815 000 060.800	M 6	8,3	12,7	5	4,0	8,0
815 000 080.800	M 8	9,9	12,7	5	4,8	9,5

1) Max. conicity + 0.04 mm

Example for finding the article number

Self-locking threaded insert B-Lok-MV with internal thread M5 and 5 vanes in brass: B-Lok-MV 815 000 050.800

Material

Brass

Article no. 800

Thread

Internal thread A: ISO 6H

Other internal threads (left-handed, unified or BA sizes, multiple threads), special dimensions and different numbers of vanes with the same length and same internal thread on request.

Tolerance

ISO 2768-m

Application

For creation of wear and vibration-resistant screw fastenings with high load capacity in

- soft plastic
- wood / fibreboard
- composite materials

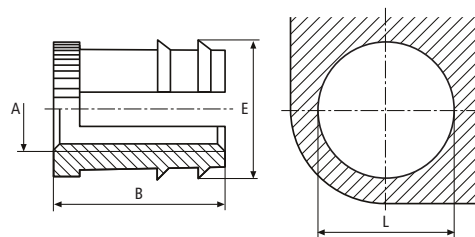

Dimensions in mm

Article no.	Internal thread	Biggest external dia.	Length	Number of vanes	Hole dia. (guideline values)
	A	E	B		L
821 000 025.800	M 2,5	5,35	4,8	1	4,5 to 4,7
821 000 030.800	M 3	5,35	4,8	1	4,5 to 4,7
821 000 035.800	M 3,5	6,0	4,8	1	5,2 to 5,4
822 000 040.800	M 4	6,65	9,5	2	5,8 to 6,0
822 000 050.800	M 5	7,35	9,5	2	6,5 to 6,7
822 000 060.800	M 6	9,05	9,5	2	8,2 to 8,4
823 000 080.800	M 8	12,5	14,3	3	11,8 to 12,0

Different lengths and numbers of vanes with the same internal thread on request. This changes the guideline values for hole diameters.

Example for finding the article number

Self-locking threaded insert B-Lok-F with internal thread M5 and 2 vanes in brass: B-Lok-F 822 000 050.800

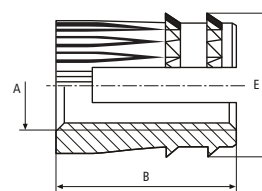

Dimensions in mm

Article no.	Internal thread	Biggest external dia.	Length B	Number of vanes	Hole dia. (guideline values)	Article no.	Biggest external dia. E	Length B	Number of gear rings
	A	E			L				
830 000 020.800	M 2	3,9	3,5	1	3,4 to 3,5				
830 000 025.800	M 2,5	4,4	4	1	3,9 to 4,0				
830 000 030.800	M 3	5,5	5	1	4,9 to 5,0	831 000 030.80	5,5	8	2
830 000 040.800	M 4	6,5	5	1	5,9 to 6,0	831 000 040.80	6,5	8	2
830 000 050.800	M 5	7,6	6	1	6,9 to 7,0	831 000 050.80	7,6	9	2
830 000 060.800	M 6	8,6	7	1	7,9 to 8,0	831 000 060.80	8,6	9	2

Example for finding the article number

Self-locking threaded insert B-Lok-E with internal thread M6 and 2 vanes in brass: B-Lok E 831 000 060.800

Material

Brass

Article no. 800

Thread

Internal thread A: ISO 6H

Tolerance

ISO 2768-m



Expansion inserts
self-locking

B-Lok®-R
Works Standard
841

Application

For creation of wear and vibration-resistant screw fastenings with high load capacity in plastic, preferably duroplastics.

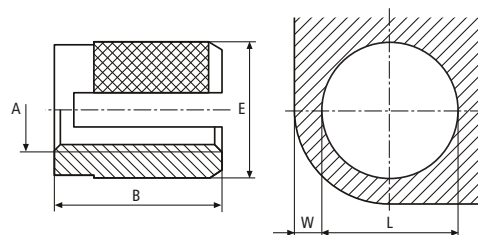

Dimensions in mm

Article no.	Internal thread	External dia.	Length	Minimum wall thickness	Hole dia. (guideline values)
	A	E	B	W	L
841 000 020.800	M 2	3,55	4,0	2,4	3,2 to 3,3
841 000 025.800	M 2,5	4,3	4,8	3,2	4,0 to 4,1
841 000 030.800	M 3	4,3	4,8	3,2	4,0 to 4,1
841 000 035.800	M 3,5	5,1	6,4	3,6	4,7 to 4,8
841 000 040.800	M 4	6,0	8,0	4,0	5,5 to 5,6
841 000 050.800	M 5	6,8	9,5	4,8	6,3 to 6,4
841 000 060.800	M 6	8,4	12,7	6,0	7,9 to 8,0
841 000 080.800	M 8	9,9	12,7	7,0	9,5 to 9,6

Example for finding the article number

Self-locking threaded insert B-Lok-R with internal thread M5 in brass: B-Lok-R 841 000 050.800



Expansion inserts
Self-locking

B-Lok®-RK
Works Standard 842

Application

With additional countering head, used in through holes in laminates and housing walls.

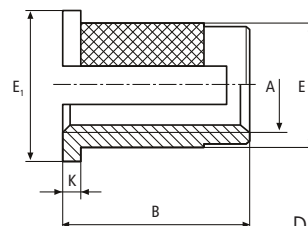

Dimensions in mm

Article no.	Internal thread	External dia.	Length	Head dia.	Head height	Minimum wall thickness	Hole dia. (guideline values)
	A	E	B	E ₁	K	W	L
842 000 020.800	M 2	3,55	4,0	4,8	0,6	2,4	3,2 to 3,3
842 000 025.800	M 2,5	4,3	4,8	5,6	0,6	2,8	4,0 to 4,1
842 000 030.800	M 3	4,3	4,8	5,6	0,6	3,2	4,0 to 4,1
842 000 035.800	M 3,5	5,1	6,4	6,4	0,8	3,6	4,7 to 4,8
842 000 040.800	M 4	6,0	8,0	7,2	0,8	4,0	5,5 to 5,6
842 000 050.800	M 5	6,8	9,5	8,0	1,0	4,8	6,3 to 6,4
842 000 060.800	M 6	8,4	12,7	9,5	1,3	6,0	7,9 to 8,0
842 000 080.800	M 8	9,9	12,7	11,0	1,3	6,0	9,5 to 9,6

Example for finding the article number

Self-locking threaded insert B-Lok-RK with internal thread M5 in brass: B-Lok-RK 842 000 050.800

Material
Thread
Tolerance

Brass
Internal thread A: ISO 6H
ISO 2768-m

Article no. 800



S-Lok® – threaded insert and stud ...

The S-Lok is a threaded insert / stud with a graduated opposing herringbone knurl on the outside and a pilot end for problem-free insertion.

Its unique shape has been tailored to the requirements of the material and was developed especially for insertion into plastic components by means of ultrasonic vibration or heat transfer.

Well-known manufacturers of ultrasonic welding machines recommend S-Lok due to the low energy requirement, the short insertion time and the problem-free production.

Product features

- Also suitable for thin-wall thicknesses, elimination of material tension.
- The firm seating is largely insensitive to borehole tolerances and material shrinkage.

Field of application

For all moulded parts made of thermoset plastics.



Design of the moulded component and receiving hole

Hole diameter (L) and wall thicknesses (W) are dependent on the material used for the formed part, the insertion method and the requirements imposed on pull-out resistance / torque safety. Please inquire or ascertain by testing. For guideline values, see the works standard sheets.

If the component offers easy mould removal, cylindrical receiving holes are recommended. For conical receiving holes: 0.5° to 4° (see works standard 853/1 and 855/1).

Countersinking (N) is recommended if embedding takes place within a taper of a $\leq 1^\circ 30'$ using heat.

Countersinking diameter = S-Lok outside diameter E.

Countersinking depth:	
M 2	~ 0,4 mm
M 2,5 / M 3,5	~ 0,5 mm
M 4 / M 5	~ 0,7 mm
M 6 / M 8	~ 1,1 mm
M 10	~ 1,4 mm

Hole depth:
(T) \geq length of the S-Lok + 1 mm

Available versions

- Standard length
- Shortened version
- Contact head for electrical contacts or simultaneous fastening of several parts
- Stud with and without contact head

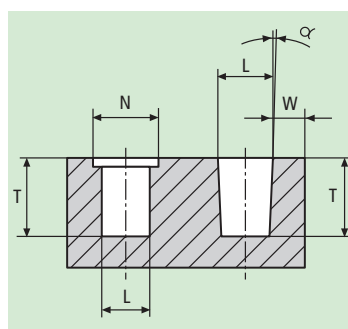

Installation

Inserts are installed by means of ultrasonic or heat transfer. This causes the plastic to soften so that it flows into the knurl profile of the S-Lok.

On subsequent cooling, a firm seat is obtained which is capable of withstanding high loads.

The pull-out resistance is generally higher than is the case with moulded-in components, and depends on the plastic, the size of the receiving hole, the wall thickness, the edge distance and the correct setting of the installation equipment.

Installation machine on request.

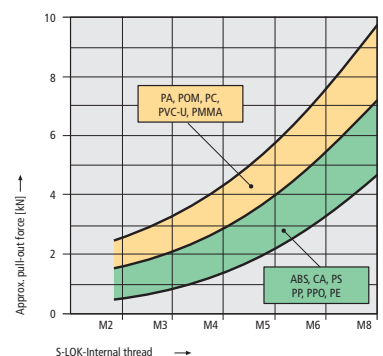

All table values apply only if the screw is inserted to at least 50% of its length in the threaded insert.

S-Lok®
Registered Trademark
GB No. 2 314 787
USA No. 2,002,590
J No. 3 150 191



Threaded inserts for heat or ultrasound embedding

S-Lok®
Works Standard
860 / 861

Application

For the manufacture of wear and vibration-resistant screw fasteners with high loading capacity in plastic, preferably thermoset plastics. The inserts are pressed into pre-formed receiving holes while the hole wall is softened using heat or ultrasound.

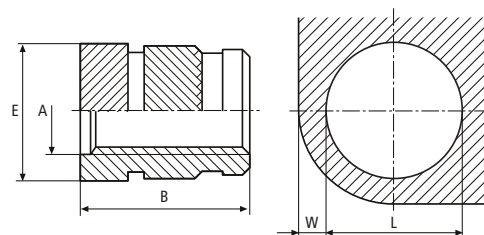

Dimensions in mm

Article no.	Internal thread	External dia.	Length	Hole dia. (Guideline values)	Minimum wall depth (with ABS)
	A	E	B	L +0,1	W
860 000 020.800	M 2	3,6	4,0	3,2	2,0
860 000 025.800	M 2,5	4,6	5,8	4,0	2,3
860 000 030.800	M 3	4,6	5,8	4,0	2,3
860 000 035.800	M 3,5	5,4	7,2	4,8	2,5
860 000 040.800	M 4	6,3	8,2	5,6	2,5
860 000 050.800	M 5	7,0	9,5	6,4	2,7
860 000 060.800	M 6	8,6	12,7	8,0	3,0
860 000 080.800	M 8	10,2	12,7	9,6	3,5
860 000 100.800	M10	12,3	12,7	11,7	4,0

Article no. short version	Length B
861 000 025.800	4,0
861 000 030.800	4,0
861 000 035.800	5,8
861 000 040.800	7,2
861 000 050.800	8,2
861 000 060.800	9,5
861 000 080.800	9,5
861 000 100.800	9,5

Example for finding the article number

Threaded insert S-Lok without head with internal thread M3 in brass: S-Lok 860 000 040.800



Threaded inserts for heat or ultrasound embedding

S-Lok®-K
Works Standard 862

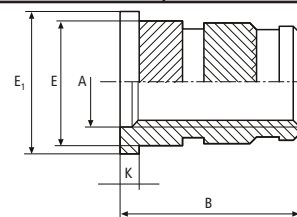

Dimensions in mm

Article no.	Internal thread	External dia. (without head)	Head dia.	Head height	Length
	A	E	E ₁	K	B
862 000 020.800	M 2	3,6	4,8	0,6	4,6
862 000 025.800	M 2,5	4,6	5,6	0,6	6,4
862 000 030.800	M 3	4,6	5,6	0,6	6,4
862 000 035.800	M 3,5	5,4	6,4	0,8	8,0
862 000 040.800	M 4	6,3	7,2	0,8	9,0
862 000 050.800	M 5	7,0	8,0	1,0	10,5
862 000 060.800	M 6	8,6	9,5	1,3	14,0
862 000 080.800	M 8	10,2	11,0	1,3	14,0
862 000 100.800	M 10	12,3	14,0	1,3	14,0

For receiving hole diameter, see article no. 860

Material Brass
Other materials, e.g. steel or aluminium, on request

Tolerance ISO 2768-m

Thread Internal thread A: ISO 6H

Article no. 800

Application

For the manufacture of wear and vibration-resistant screw fasteners with high loading capacity in plastic, preferably materials subject to cracking (age cracks) such as polycarbonate.

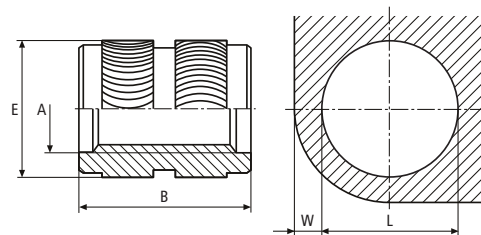

Dimensions in mm

Article no.	Internal thread	External dia.	Length	Hole dia. (Guideline values)	Minimum wall depth
	A	E	B	L + 0,1	W
863 000 020.800	M 2	3,5	4,0	3,2	1,50
863 000 025.800	M 2,5	4,4	5,8	4,0	1,80
863 000 030.800	M 3	4,4	5,8	4,0	1,80
863 000 035.800	M 3,5	5,2	7,2	4,8	2,20
863 000 040.800	M 4	6,0	8,2	5,6	2,50
863 000 050.800	M 5	6,8	9,5	6,4	3,00
863 000 060.800	M 6	8,4	12,7	8,0	3,50
863 000 080.800	M 8	10,0	12,7	9,6	4,50
863 000 100.800	M 10	12,3	12,7	11,9	5,50

Example for finding the article number:

Threaded insert S-Lok-R of works standard series 863 with internal thread M4 in brass: S-Lok-R 863 000 040.800

Application

Easily sortable due to their symmetrical shape and usable on both sides, suitable for all applications in thermoset plastics.

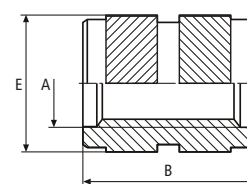

Dimensions in mm

Article no.	Internal thread	External dia.	Length
	A	E	B
864 000 020.800	M 2	3,6	4,0
864 000 025.800	M 2,5	4,6	5,8
864 000 030.800	M 3	4,6	5,8
864 000 035.800	M 3,5	5,4	7,2
864 000 040.800	M 4	6,3	8,2
864 000 050.800	M 5	7,0	9,5
864 000 060.800	M 6	8,6	12,7
864 000 080.800	M 8	10,2	12,7
864 000 100.800	M 10	12,5	12,7

For receiving hole diameter, see article no. 863

Material Brass Article no. 800
Tolerance ISO 2768-m
Thread as per ISO 6H



Threaded inserts
for heat or ultrasound embedding

S-Lok®-KO
Works Standard
853 1 / 854 1

Application

For the manufacture of wear and vibration-resistant screw fasteners with high loading capacity in plastic, preferably thermoset plastics. The inserts are pressed into pre-formed receiving holes with 4° demoulding incline

during softening of the hole wall by means of heating or ultrasonic technology.

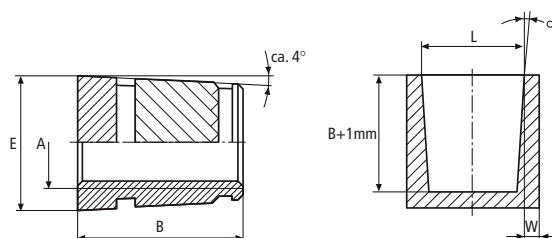

Dimensions in mm

Article no.	Internal thread	External dia.	Length	Hole dia. (Guideline values)	Minimum wall depth
	A	E	B	L +0,1	W
853 100 020.800	M 2	4,1	5,0	3,8	1,5
853 100 025.800	M 2,5	4,1	5,0	3,8	1,5
853 100 030.800	M 3	4,6	5,5	4,4	1,8
853 100 035.800	M 3,5	5,4	6,0	5,2	1,8
853 100 040.800	M 4	6,0	7,5	5,8	2,0
853 100 050.800	M 5	7,2	9,0	6,9	2,0
853 100 060.800	M 6	8,8	10,0	8,5	2,5
853 100 080.800	M 8	11,2	12,0	10,9	3,0

Article no. short version	Length B
854 1 030.80	5,0
854 1 035.80	5,5
854 1 040.80	6,0
854 1 050.80	7,5
854 1 060.80	9,0
854 1 080.80	10,0

Example for finding the article number

Threaded insert S-Lok-KO of works standard series 853 1 with demoulding incline 4°, internal thread M4, length 7.5 mm in brass: S-Lok-KO 853 100 040.800



Threaded inserts
for heat or ultrasound embedding

S-Lok®-KOK
Works Standard 855 1

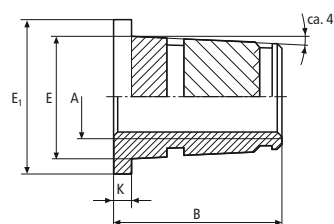

Dimensions in mm

Article no.	Internal thread	External dia. (without head)	Head dia.	Head height	Length
	A	E	E ₁	K	B
855 100 020.800	M 2	4,1	5,6	0,6	5,6
855 100 025.800	M 2,5	4,1	5,6	0,6	5,6
855 100 030.800	M 3	4,6	6,4	0,6	6,1
855 100 035.800	M 3,5	5,4	7,2	0,8	6,8
855 100 040.800	M 4	6,0	8,0	0,8	8,3
855 100 050.800	M 5	7,2	9,0	1,0	10,0
855 100 060.800	M 6	8,8	10,0	1,3	11,3
855 100 080.800	M 8	11,2	12,5	1,3	13,3

For receiving hole diameter, see article no. 853

Material Brass Article no. 800
Tolerance ISO 2768-m
Thread as per ISO 6H

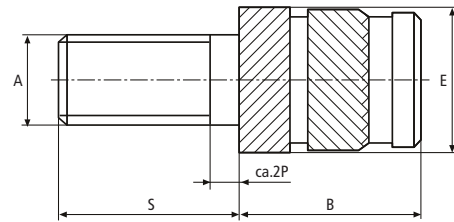

Available stud lengths
(other lengths on request)

Dimensions in mm

Article no.	Thread	External dia.	Inserted length
	A	E	B
866 000 020.8..	M 2	3,6	4,0
866 000 025.8..	M 2,5	4,6	5,8
866 000 030.8..	M 3	4,6	5,8
866 000 035.8..	M 3,5	5,4	7,2
866 000 040.8..	M 4	6,3	8,2
866 000 050.8..	M 5	7,0	9,5
866 000 060.8..	M 6	8,6	12,7
866 000 080.8..	M 8	10,2	12,7

Article no. (eleventh digit)	Length S	Available		
		M 2 M 2,5	M 3 M 3,5 M 4	M 5 M 6 M 8
... .. .20	6	X	X	X
... .. .40	10	X	X	X
... .. .60	16	X	X	X
... .. .80	25	X	X	X

Thread length = S - 2P
P = Threaded pitch

For receiving hole diameter, see article no. 860

Example for finding the article number

S-Lok-S stud M4 of works standard series 866, length of the stud S = 10 mm in brass: S-Lok-S 866 000 040.840

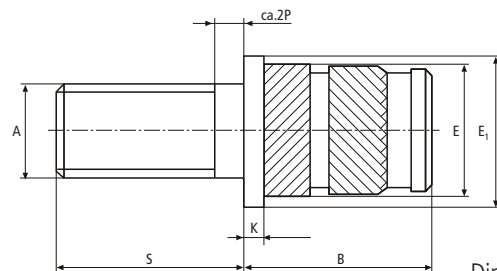

Dimensions in mm

Article no.	Thread	External dia. (without head)	Head dia.	Head height	Length
	A	E	E ₁	K	B
867 000 020.8..	M 2	3,6	4,8	0,6	4,6
867 000 025.8..	M 2,5	4,6	5,6	0,6	6,4
867 000 030.8..	M 3	4,6	5,6	0,6	6,4
867 000 035.8..	M 3,5	5,4	6,4	0,8	8,0
867 000 040.8..	M 4	6,3	7,2	0,8	9,0
867 000 050.8..	M 5	7,0	8,0	1,0	10,5
867 000 060.8..	M 6	8,6	9,5	1,3	14,0
867 000 080.8..	M 8	10,2	11,0	1,3	14,0

Available stud lengths: See table

For receiving hole diameter, see article no. 860

Material

Brass

Article no. 800

Other materials, e.g. steel or aluminium, on request

Tolerance

ISO 2768-m

Thread

as per ISO 6g



Threaded studs
for heat or ultrasound embedding

S-Lok®-KOS
Works Standard
858 1

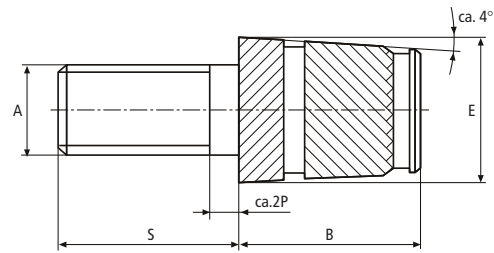

Available stud lengths
(other lengths on request)

Dimensions in mm

Article no.	Thread	External dia.	Inserted length
	A	E	B
858 100 020.8..	M 2	4,1	5,0
858 100 025.8..	M 2,5	4,1	5,0
858 100 030.8..	M 3	4,6	5,5
858 100 035.8..	M 3,5	5,4	6,0
858 100 040.8..	M 4	6,0	7,5
858 100 050.8..	M 5	7,2	9,0
858 100 060.8..	M 6	8,8	10,0
858 100 080.8..	M 8	11,2	12,0

Article no. (eleventh digit)	Length S	Available		
		M 2 M 2,5	M 3 M 3,5 M 4	M 5 M 6 M 8
... ..20	6	X	X	X
... ..40	10	X	X	X
... ..60	16	X	X	X
... ..80	25	X	X	X

Thread length = S - 2P
Threaded pitch = P

For receiving hole diameter, see article no. 853

Example for finding the article number

S-Lok-KOS stud M4 for conically pre-formed receiving holes of works standard series 858 1, length of the stud S = 10 mm in brass: S-Lok-KOS 858 000 040.840



Threaded studs
for heat or ultrasound embedding

S-Lok®-KOSK
Works Standard 859 1

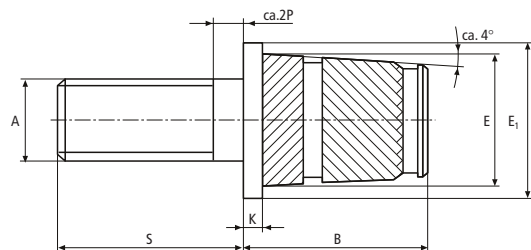

Dimensions in mm

Article no.	Thread	External dia. (without head)	Head dia.	Head height	Length
	A	E	E ₁	K	B
859 100 020.8..	M 2	4,1	5,6	0,6	5,6
859 100 025.8..	M 2,5	4,1	5,6	0,6	5,6
859 100 030.8..	M 3	4,6	6,4	0,6	6,1
859 100 035.8..	M 3,5	5,4	7,2	0,8	6,8
859 100 040.8..	M 4	6,0	8,0	0,8	8,3
859 100 050.8..	M 5	7,2	9,0	1,0	10,0
859 100 060.8..	M 6	8,8	10,0	1,3	11,3
859 100 080.8..	M 8	11,2	12,5	1,3	13,3

Available stud lengths: See table

For receiving hole diameter, see article no. 853

Material Brass Article no. 800
Tolerance ISO 2768-m
Thread as per ISO 6g

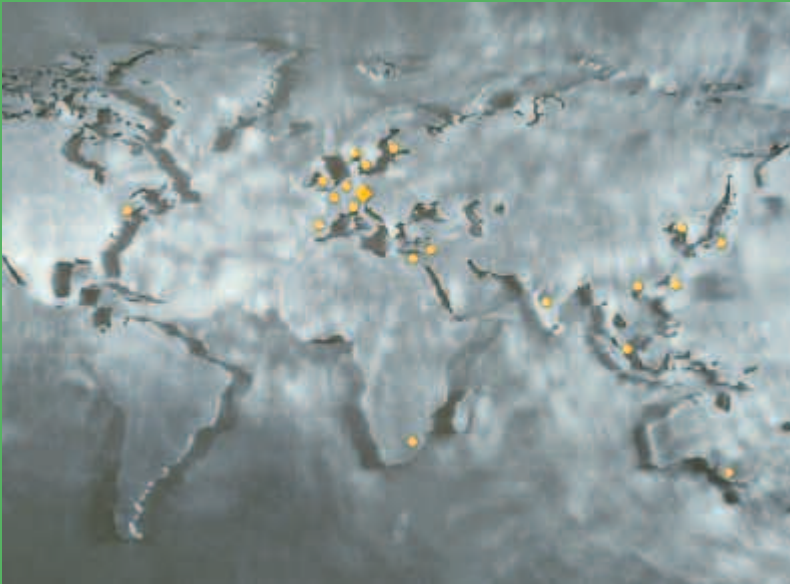

KerbKonus - Close to its customers. Around the world. Across every sector of industry.

First and foremost, for you customer proximity means a rapid response to your requirements and the fast, efficient realisation of the right fastening solution for you.

For us, customer proximity is far more than just another watchword - it is an important strategic instrument. Our technical sales consultants are available locally to talk to you around the world, ready to offer sound advice when it comes to the reliable, economical application of modern fastening technology. Advisory activities are coordinated through the headquarters in Amberg.

Why not simply call us to arrange an appointment?

Kerb-Konus-Vertriebs-GmbH

P.O.Box 16 63
D-92206 Amberg

Phone ++49 9621 679-0
Fax ++49 9621 679444
e-mail KKV-Amberg@kerbkonus.de

Internet www.kerbkonus.de

... in Germany

Amberg Headquarters

Kerb-Konus-Vertriebs-GmbH
Werner-von-Braun-Straße 7
D-92224 Amberg

Production and Sales Hadamar

... and around the world.

**Kerb-Konus
Fasteners Pvt. Ltd.**
Kolhapur/India

KKV Corp.
Osaka/Japan

KKV AG
Sattel/Switzerland

Precision Fasteners Inc.
Flanders, New Jersey/USA

Kerb-Konus Italia s.r.l.
Mulazzano/Italy

Kerb-Konus UK
Telford/Shropshire
UK

Kerb Konus Espanola S. A.
Alcorcon/Madrid
Spain

KKV Belgium
Gooik/Belgium

Sofrafix
Savigny-le-Temple
France

Other foreign agents in a wide number of countries.
Addresses on request or under www.kerbkonus.de

